

Multiple Gas#3 plus Sulfur GC Configuration

The SRI Model 8610C Gas Chromatograph (GC) configured as a MultipleGas#3 plus Sulfur is designed to measure H₂, O₂, N₂, CO, CO₂, H₂O, C₁ through C₅ hydrocarbons and also H₂S, COS/SO₂, and other sulfur molecules such as mercaptans, CS₂, DMS, DMDS, Thiophenes and more in a single analysis.

The GC is equipped with three detectors:

The Thermal Conductivity Detector (TCD) measures all non-sulfur molecules from 500ppm to 100%

The FID/Methanizer detector (FID/meth) measures hydrocarbons plus CO and CO₂ from 1ppm to 50,000ppm

The Flame Photometric/FID combo detector (FPD/FID) measures all sulfur molecules plus hydrocarbons.

Inside the column oven are three columns.

The Haysep-D (HD) and MoleSieve (MS13X) columns together separate H₂, O₂, N₂, CO, CO₂ and C₁-C₅ hydrocarbons as well as water.

The 60meter MXT1 capillary column separates the sulfur molecules and also hydrocarbons from C₁-C₁₀

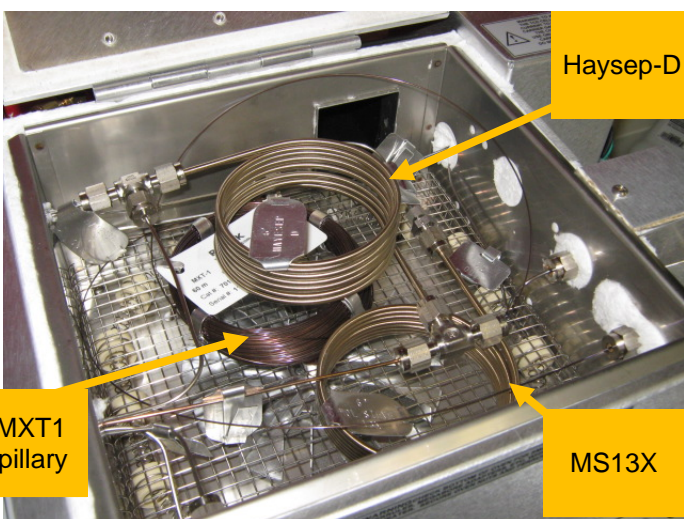
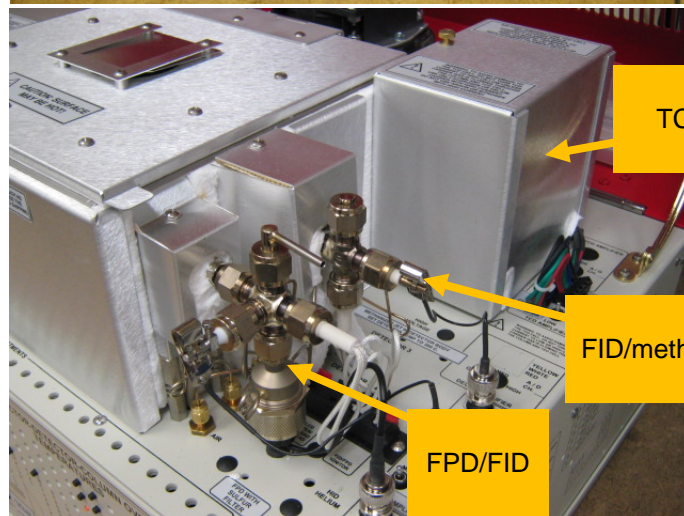

SRI Tech Support: 310-214-5092
www.srigc.com

Multiple Gas#3 plus Sulfur GC Configuration

The 60meter MXT1 capillary column is connected to the Haysep-D column using a “tee” fitting. When the sample is injected, it is split so about half the sample flows into the HD column and the other half flows into the capillary column. Notice how the cap column is inserted into the sample delivery tube in such a way that the sample splits cleanly. If the connection is not made in this way, the peaks will not be as sharp.

The other end of the capillary column is connected to the FPD/FID detector using a Swagelok nut and graphite ferrule.

The TCD and FID/methanizer detectors are connected in series, so all molecules exit the HD/MS13x columns and flow first through the TCD and then exit the TCD and flow into the FID/methanizer via a 1/16' stainless steel tube.

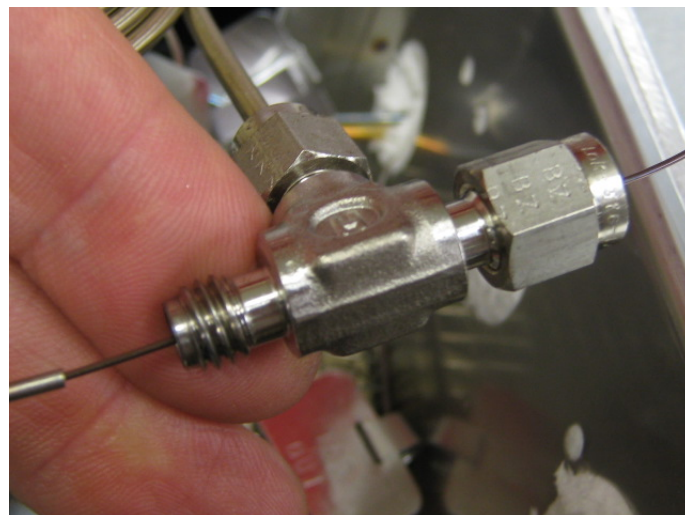

Multiple Gas#3 plus Sulfur GC Configuration

A 10 port Valco gas sampling valve is mounted in the heated valve oven.

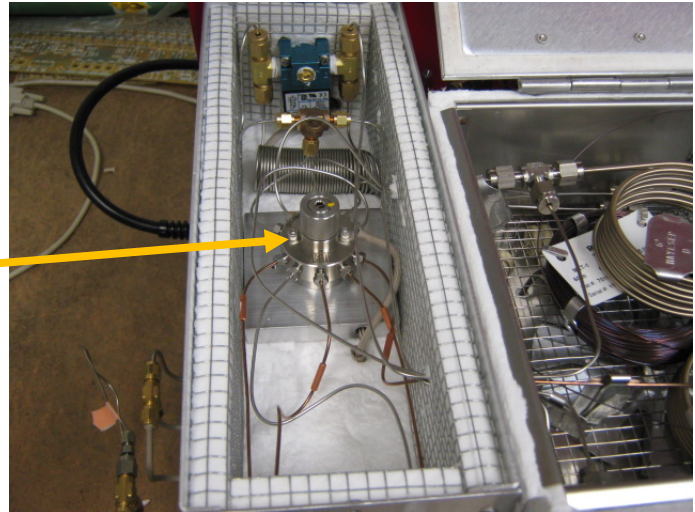

The valve is plumbed as shown in the diagram.

In the Load position the carrier gas flows through the three columns and into the detectors but the sample loop is isolated so sample can be loaded into the loop.

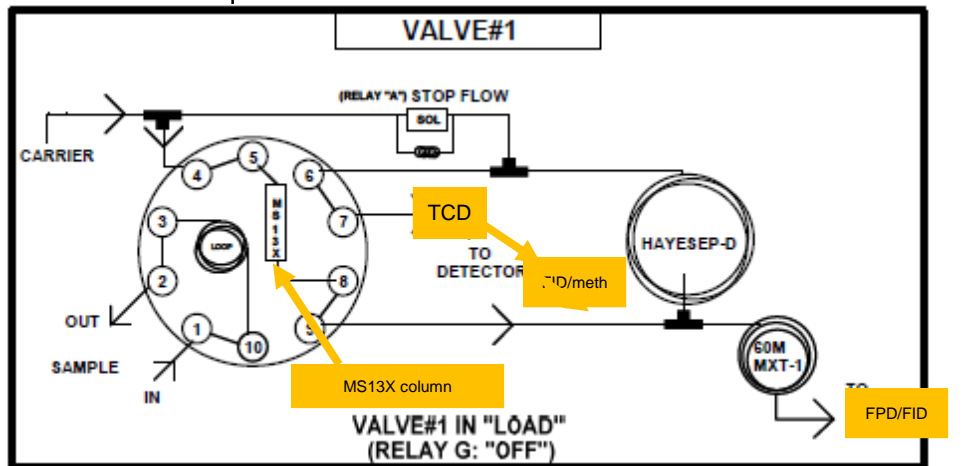

When the analysis is started, the valve rotates to the Inject position so the carrier gas now pushes the sample out of the loop, to the "tee" fitting where it splits into two paths.

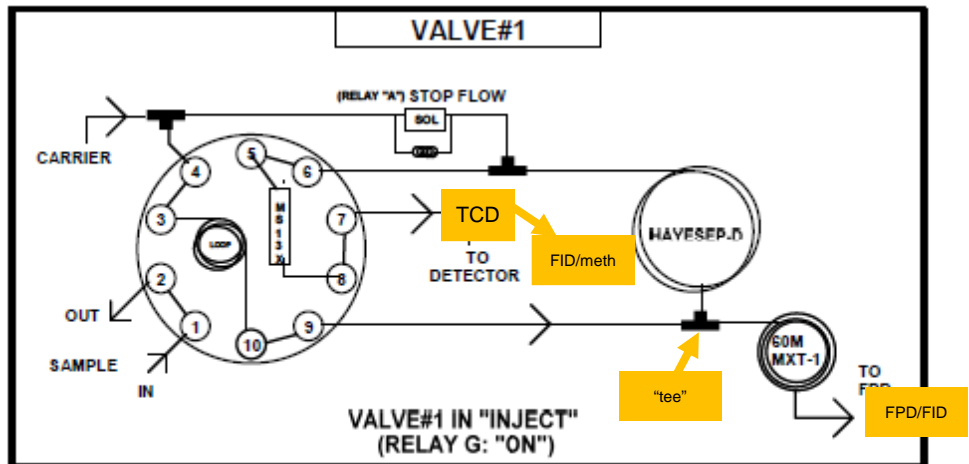

Multiple Gas#3 plus Sulfur GC Configuration

The sample loop is loaded with new sample by flushing the loop with 10ml or more of fresh sample. The loop itself is 1ml, but it takes 10ml to completely flush it. Sulfur compounds like H₂S can be lost on active metal surfaces, so we use a special kind of tubing to make the loop called "Sulfinert".

Sample can be pushed through the loop with a syringe, or it can flow continuously, or it can be pulled through with suction (vacuum pump). For sulfur compounds it is important to use Teflon tubing to avoid losses.

The GCs temperature program and event table is set up as shown. Users may expect to make modifications depending on the exact molecules being measured.

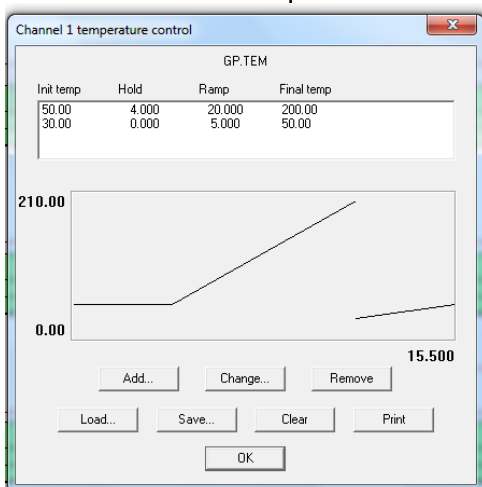
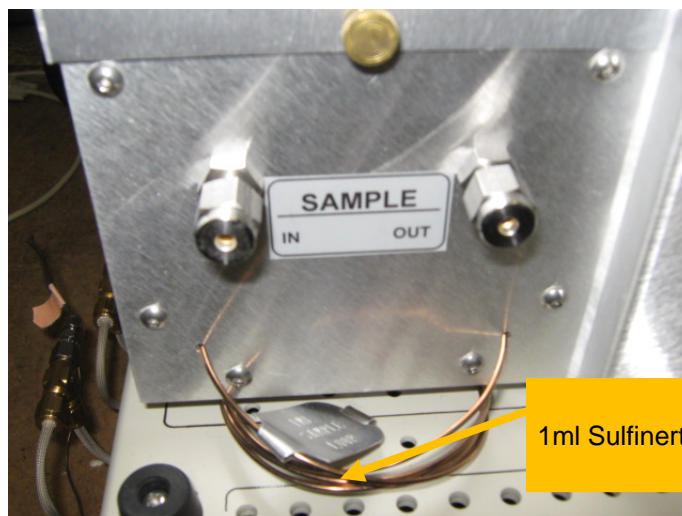

Time	Event
0.000	ZERO
0.000	SOUND
0.020	A ON (StopFlow)
0.050	A OFF (StopFlow)
0.100	G ON (ValveRotate)
1.600	A ON (StopFlow)
5.500	A OFF (StopFlow)
5.500	G OFF (ValveRotate)



Multiple Gas#3 plus Sulfur GC Configuration

Since there are four detectors, the PeakSimple software will show four chromatograms simultaneously on the computer monitor.

Zooming in on the FPD chromatogram you can see Hydrogen Sulfide (H₂S), Carbonyl Sulfide (COS) and Di Methyl sulfide (DMS). The FPD is blind to hydrocarbons like methane.

The FID part of the FPD/FID combo detector detects methane and DMS (C₂H₆S), but does not detect H₂S and COS since the FID only detects molecules with carbon-hydrogen bonds. When the FPD/FID combo detector is optimized for best sulfur detection, the FID sensitivity and range is reduced to less than what a normal FID detector would deliver.

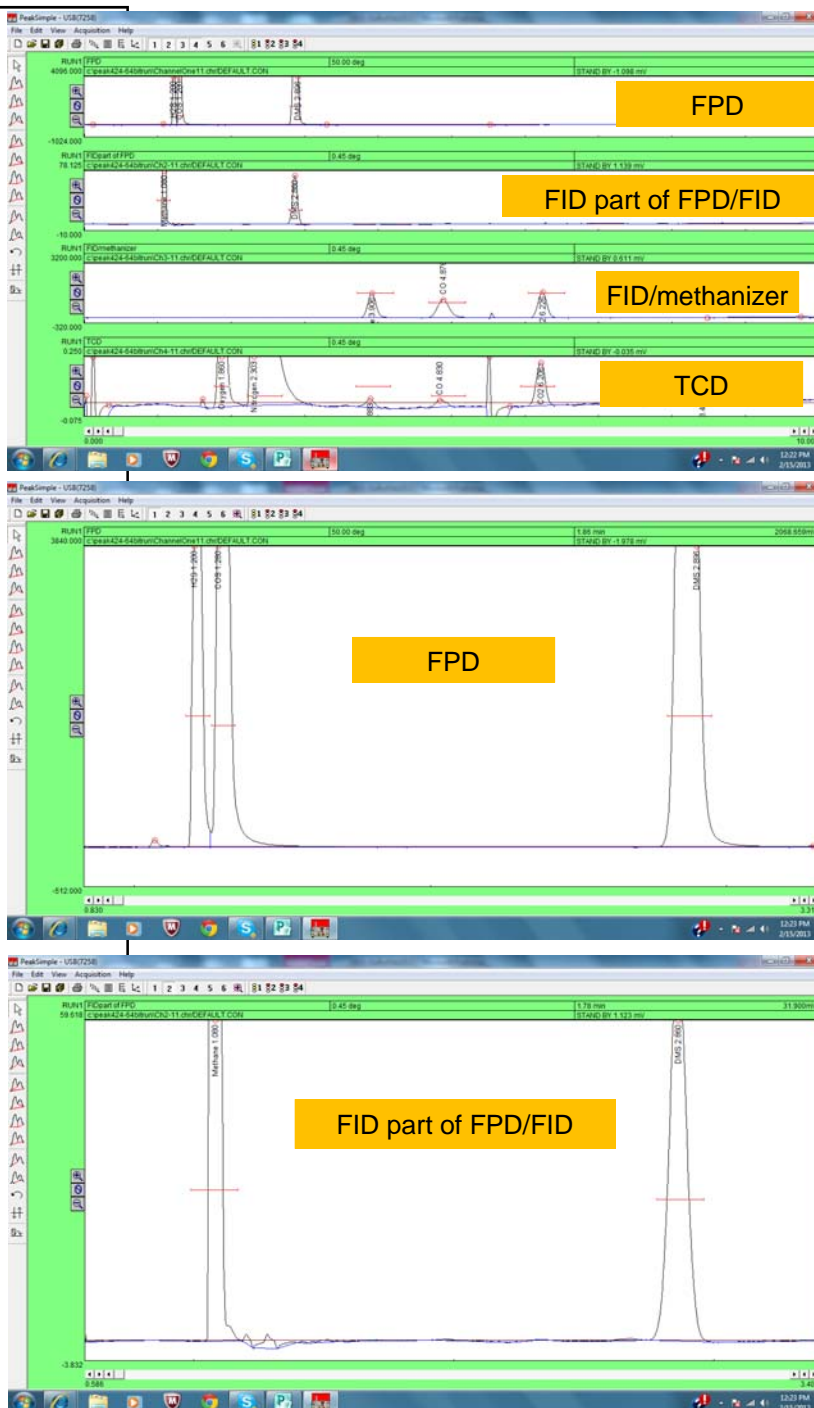

Multiple Gas#3 plus Sulfur GC Configuration

The FID/methanizer detects all hydrocarbons from methane to hexane and also CO and CO₂ which are converted to methane by the methanizer. Detection from 1ppm to 50,000ppm are possible. Shown are methane, CO and CO₂ at 1000ppm.

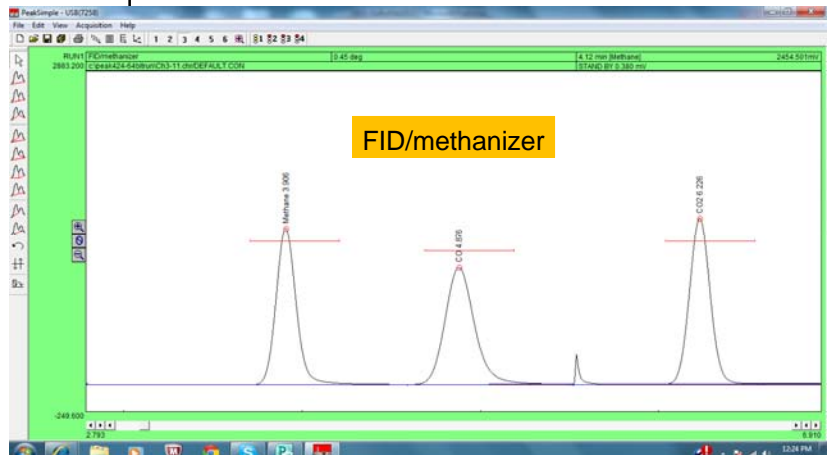

The TCD detects Hydrogen, Oxygen, Nitrogen, Methane, CO, CO₂, Water and all molecules with boiling points below hexane. Detection of most molecules is possible from 500ppm to 100%. Hydrogen can be detected from 10ppm to 100% if using Nitrogen or Argon carrier, but this increases detection limits for everything else from 500ppm to about 5000ppm. With helium carrier detection limit for hydrogen is about 10,000ppm to 100%.

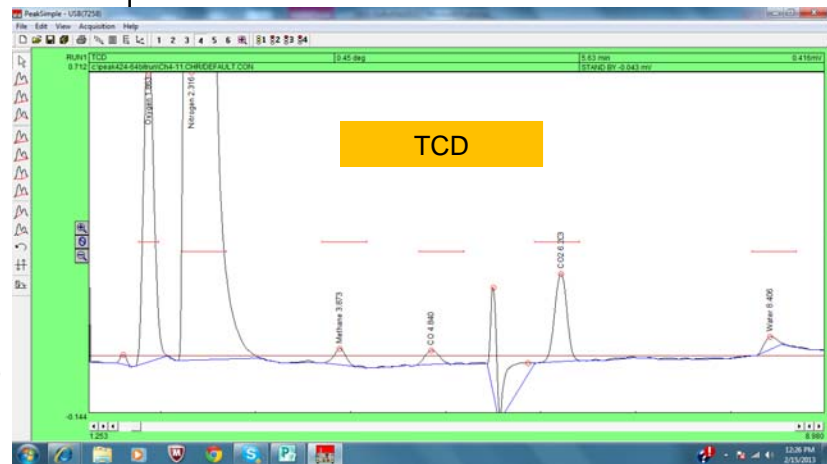

In some cases, the GC can be equipped with a second TCD detector, valve and column specifically to detect Hydrogen while helium carrier is used for the other molecules.

